

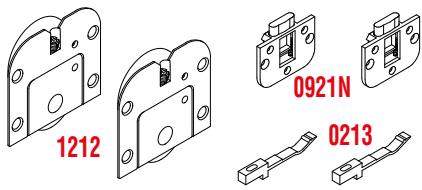

## KIT 0921-1212 NN - MAX 30 KG

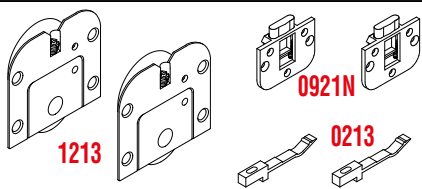



## KIT 0921-1213 NN - MAX 30 KG



### Legenda KIT / Kit Legend

<b>1212</b>	Carrello inferiore con rullo regolabile <i>Lower adjustable truck with roller</i>
<b>1213</b>	Carrello inferiore con cuscinetto regolabile <i>Lower adjustable truck with ball bearing</i>
<b>0213</b>	Fermo superiore per profilo Art. 0211 <i>Upper stopper for profile Art. 0211</i>
<b>0921N</b>	Catenacciolo superiore <i>Upper security chain</i>

### Legenda altri componenti *Legend other items*

<b>0211</b>		Profilo plastica superiore <i>Upper plastic profile</i>
<b>0380</b>		Profilo alluminio inferiore <i>Lower aluminium profile</i>
<b>0300</b>		Profilo alluminio inferiore <i>Lower aluminium profile</i>

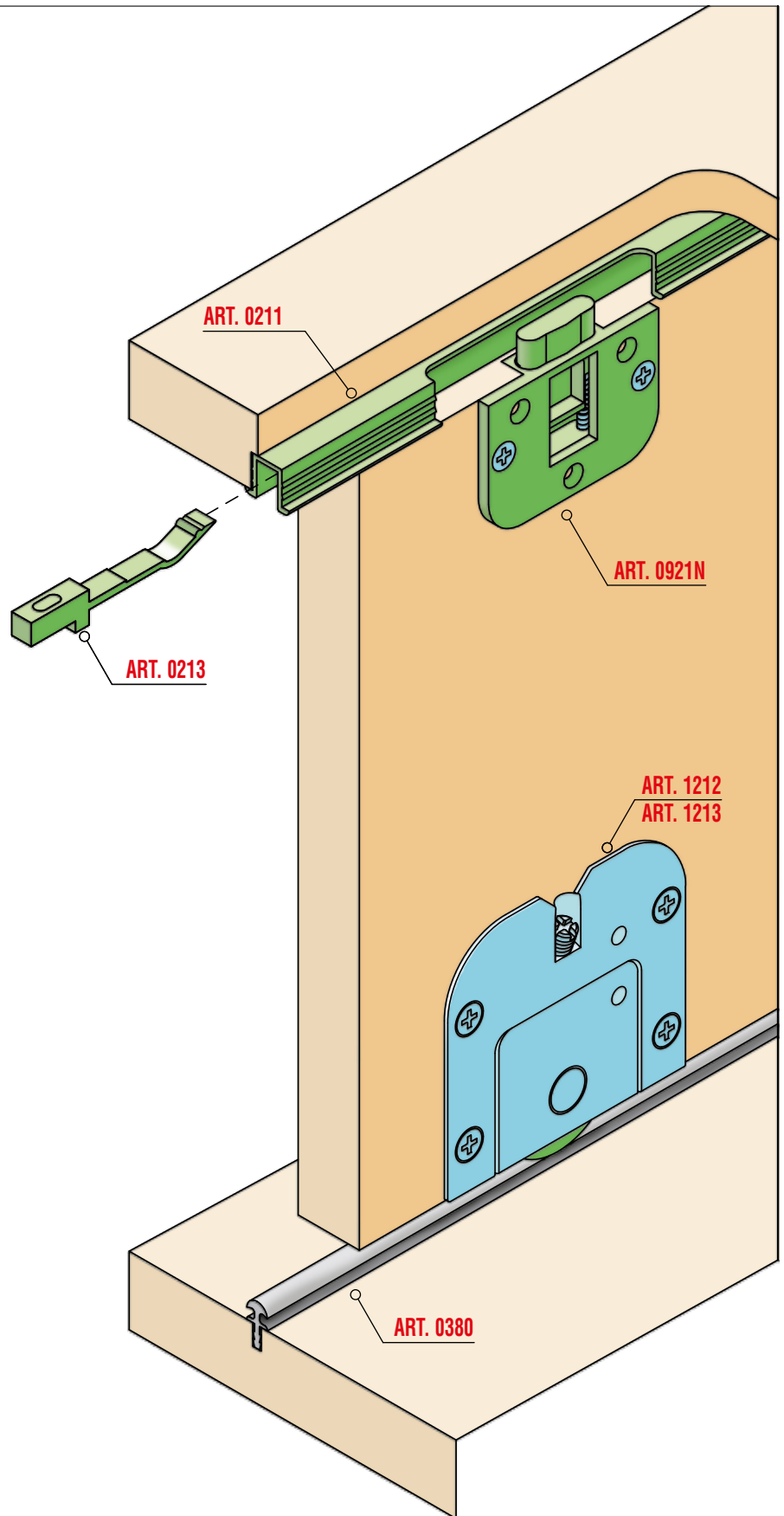



Sistemi scorrevoli per mobili / Sliding systems for furniture

## Sezione verticale / Vertical section

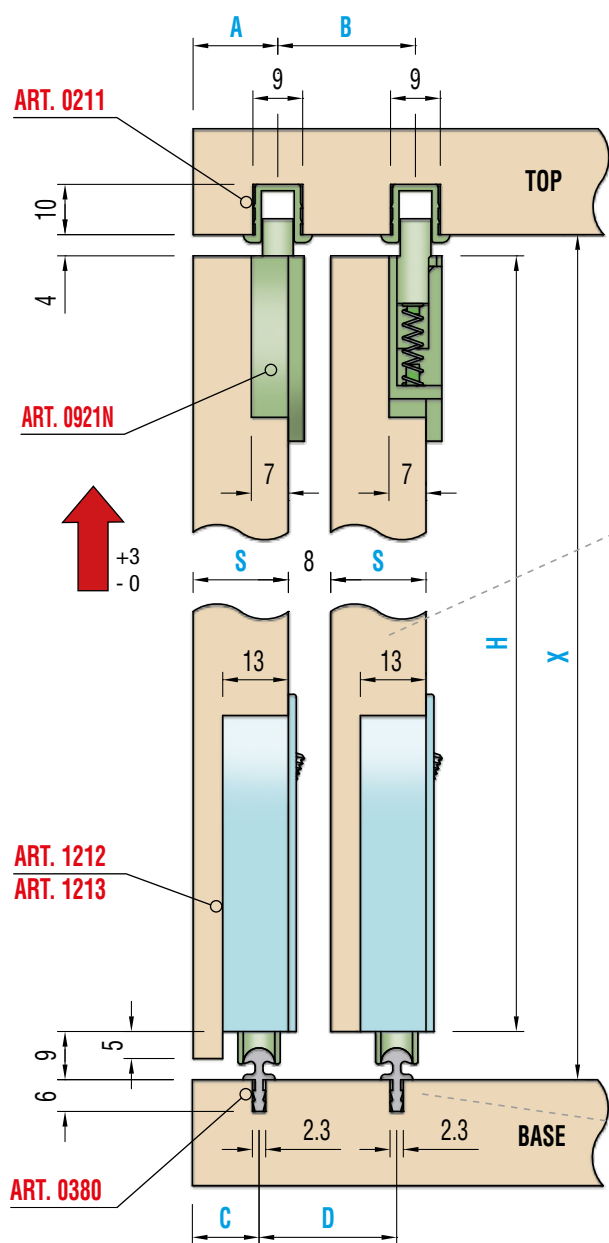

Peso massimo anta Kg. 30  
Maximum door weight Kg 30

A =	S* -2
B =	S* +8
C =	S* -5,5
D =	S* +8
H =	X -13

S\* (spessore / thickness)  
min.16

### Variante Special version

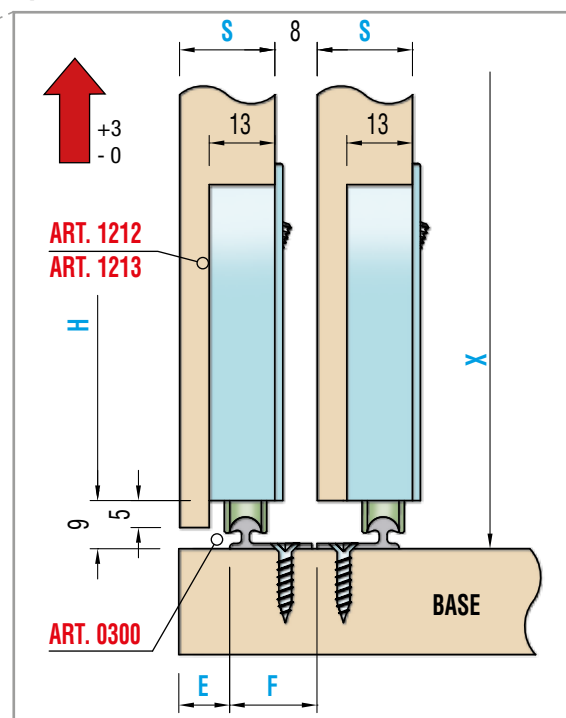

E =	S* -8,5
F =	S* -1,5
H =	X -13

## Schema Foratura ante / Doors drilling

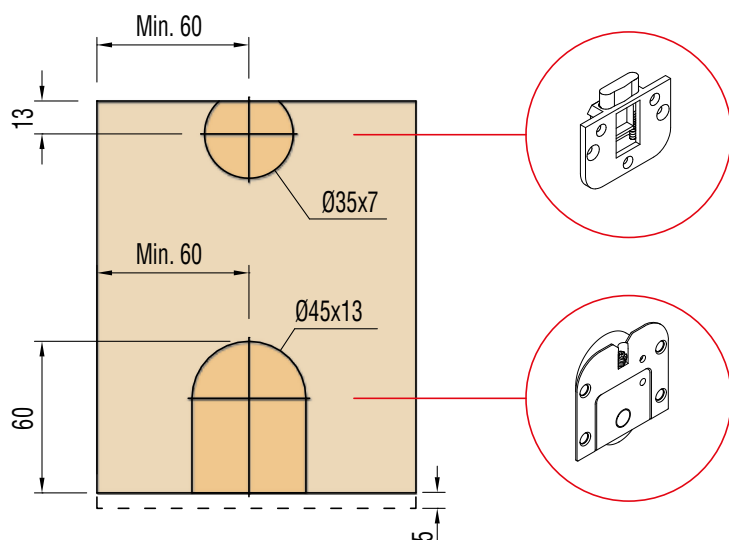

## Schema di montaggio / Assembling

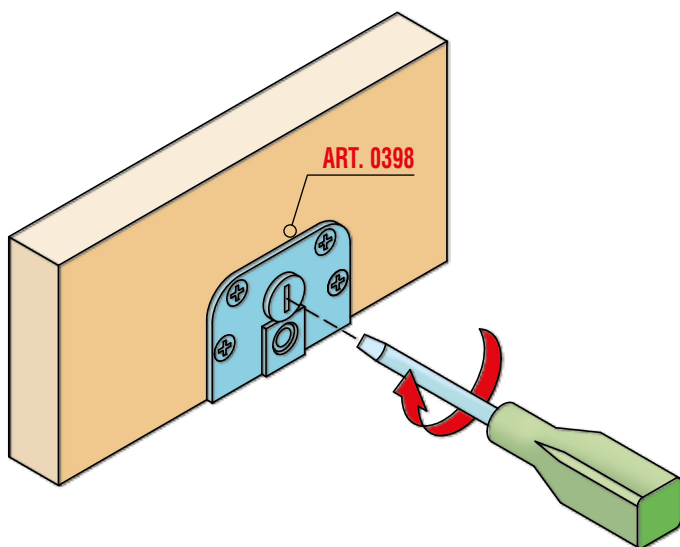

### REGOLAZIONE CARRELLO ART.0398 ADJUSTING TRUCK ART.0398

Montare l'anta sul mobile e se necessario, regolarla ruotando l'eccentrico con un cacciavite.

*Fit the door to the furniture piece. if necessary adjust it by turning the eccentric by screw-driver.*

### MONTAGGIO ANTE CON ART.0320 E 0390 FITTING OF DOORS CON ART.0320 E 0390

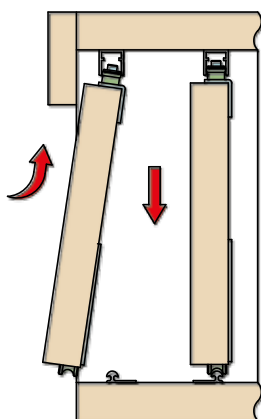

### MONTAGGIO ANTE CON ART.0211 E 0902 FITTING OF DOORS CON ART.0211 E 0902

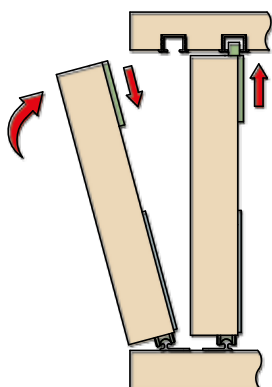

### MONTAGGIO ED USO DEI CARRELLI REGOLABILI ART.0304

1

Montare sull'anta i carrelli ART.0304 avvitando le viti nei fori asolati inferiori senza stringerle.

*Fit trucks ART.0304 to the door and turn the screws in the lower slots without tightening.*

2

Montare l'anta sul mobile e, se necessario, regolarla ruotando l'eccentrico con una chiave esagonale da mm 6.

*Fit the door to the furniture piece. If necessary, adjust it by turning the eccentric by means of a mm 6 hexagonal wrench.*

3

Infine stringere le viti precedentemente montate nei fori inferiori e bloccare il carrello avvitando ancora le viti nei fori superiori.

*Then tighten the screws previously inserted into the lower slots and lock the truck by tightening the screws in the upper slots.*

### FITTING AND USE THE ADJUSTABLE TRUCKS ART.0304

1

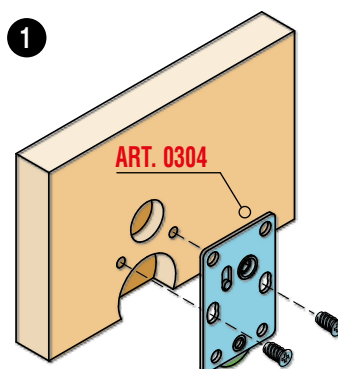

2

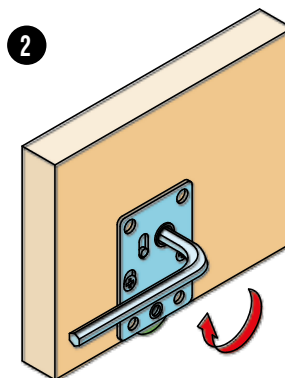

3

